

MPB25 Series

25mm Metal Pushbutton Switches



SPECIFICATIONS

RATING : 1th 5A/250VAC resistive load 3A/250VAC
CONTACT RESISTANCE : 50 mΩ max. @ 1A 12VDC (initial value)
INSULATION RESISTANCE : 1,000 MΩ min. at 500VDC
DIELECTRIC STRENGTH : 2,000V RMS @ sea level
OPERATION TEMPERATURE : -20°C to 55°C
MECHANICAL LIFE : Momentary 1,000,000 cycles
 Self-lock 500,000 cycles
ELECTRICAL LIFE : 50,000 make-and-break cycles at full load
TORQUE : 5~14Nm
PANEL THICKNESS : 10mm (Ø25.20mm)
OPERATION PRESSURE : 1Pole 2.5±1N / 2Poles 3.5±1N
TRAVEL : About 3.2mm
INGRESS PROTECTION : IP67, IK08(Stainless)

MATERIALS

BUSHING : Stainless Steel / Aluminum alloy
BASE : PBT(UL 94-V0) , PC(UL 94-V2)
ACTUATOR : PC; Stainless Steel / Aluminum alloy
INNER ASSEMBLY : POM / PA66.
SPRING : Spring steel.
SEALING : Silicone.
O-Ring : Silicone.
TERMINAL : Brass,with silver or gold plated.
CONTACT :
 Q=Copper ,Silver plated.
 R=Brass,Coin silver,Gold plated
HEX NUT : Nickel plated brass

HOW TO ORDER

IP 67
ACCORDING TO
 EN 60528:1991+A1:2001
 IEC 60529:2001

C **UL** US
E 187490

RoHS
compliant

RoHS
lead-free

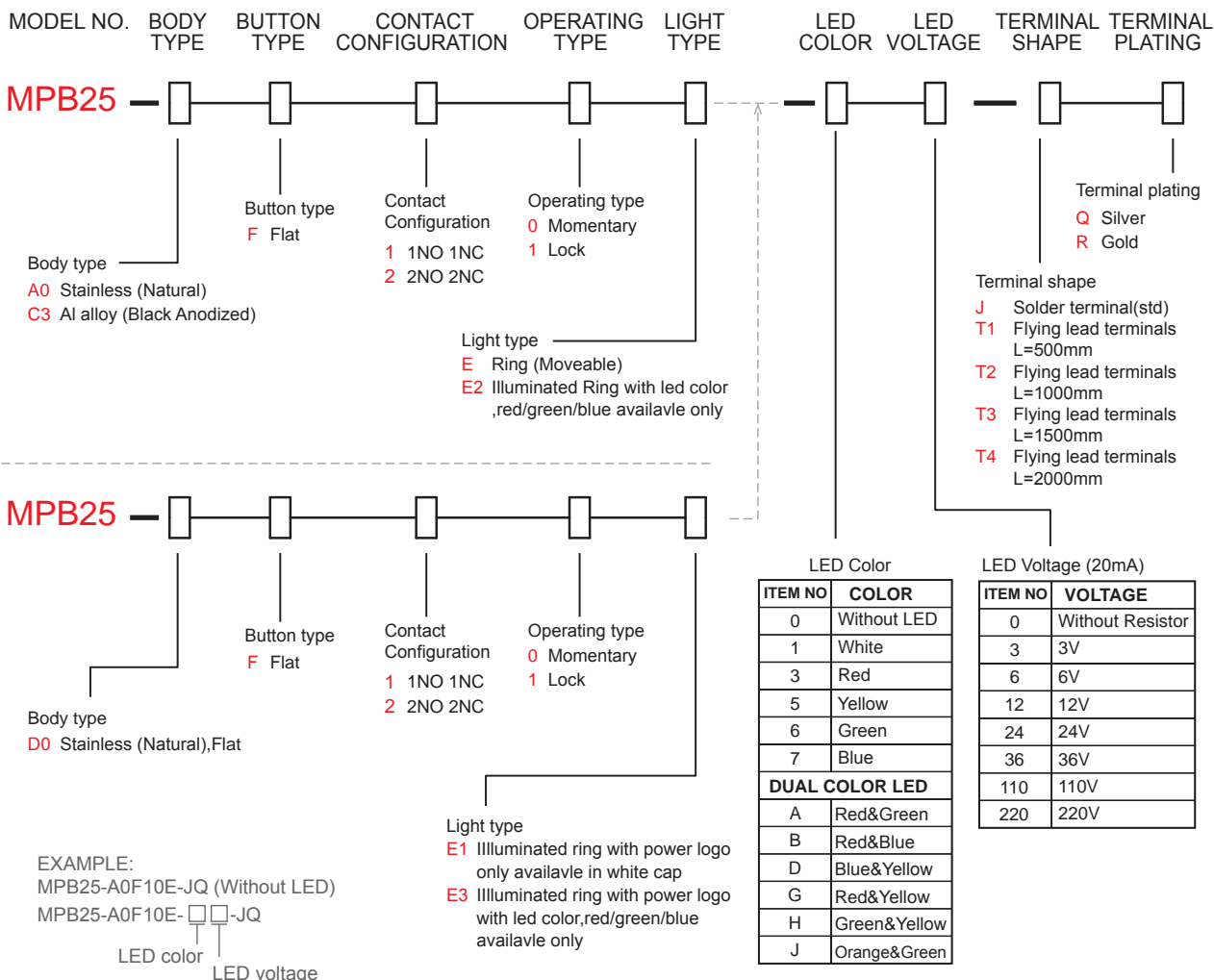

MPB25 Pushbutton Switches

MPB25 Series

25mm Metal Pushbutton Switches

CIRCUIT

POSITION 1

POSITION 2



Without LED (1 Pole)

POSITION 1

POSITION 2

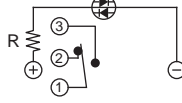
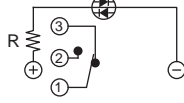

Single Color Led (1 Pole)

POSITION 1

POSITION 2

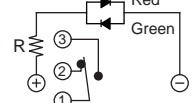
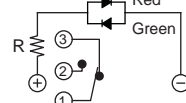

Dual Color Led (1 Pole)

POSITION 1

POSITION 2

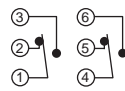
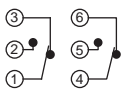

Without LED (2 Poles)

POSITION 1

POSITION 2

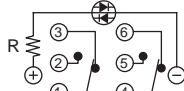

Single Color Led (2 Poles)

POSITION 1

POSITION 2

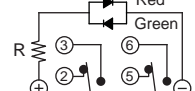
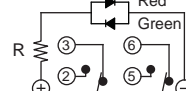

Dual Color Led (2 Poles)

BODY TYPE

A0/C3 Body

D0 Body (Flat)

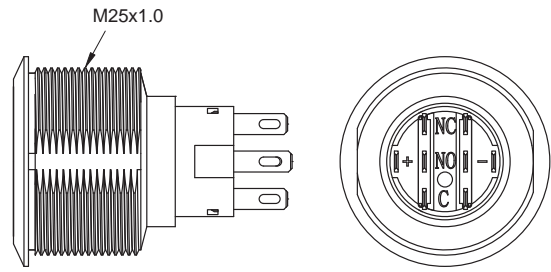
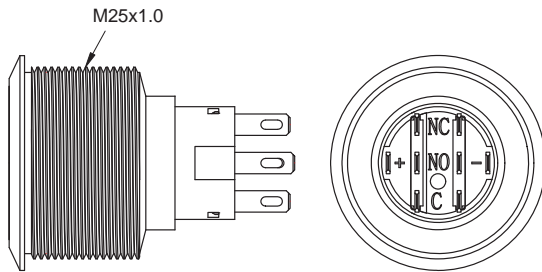

LIGHT TYPE

E Ring (Moveable)

E3 Ring+Power logo

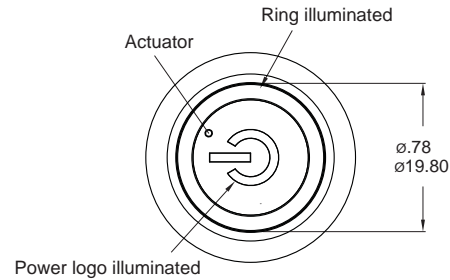
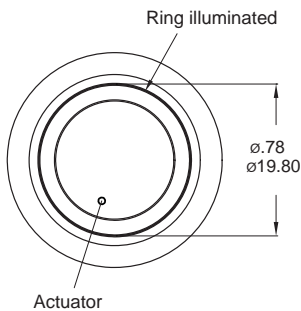

* Only for D0 body type.

Wire (Flying lead Terminals)

※ Wire=UL 3385,18AWG,300V(Black/Yellow/Green/Red/Purple)

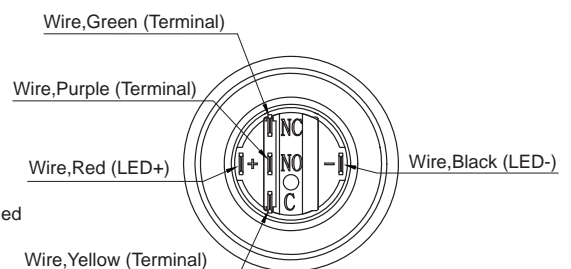
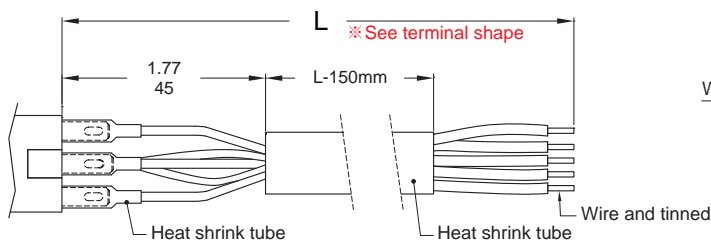

LIGHT TYPE

E Ring (Moveable)

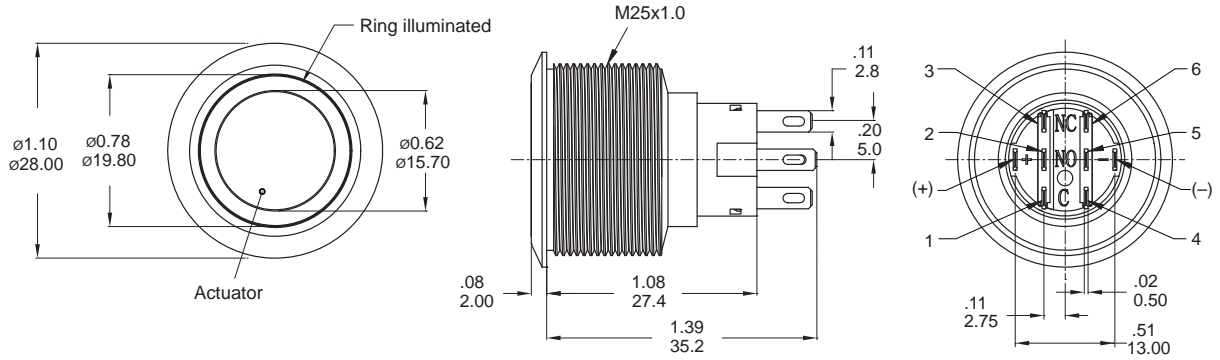

Part No. Shown : MPB25-A0F2□E-□□-JQ

E3 Ring+Power logo

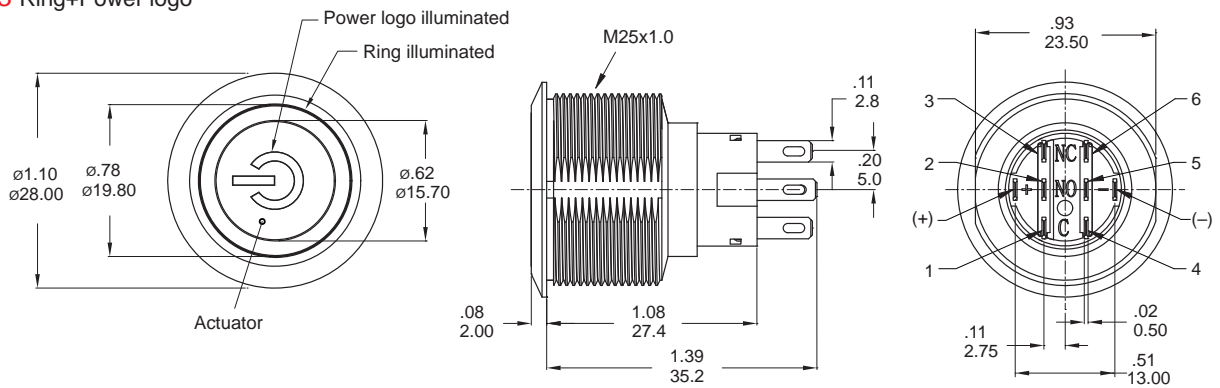

Part No. Shown : MPB25-D0F2□E3-□□-JQ

ASSEMBLED VIEW

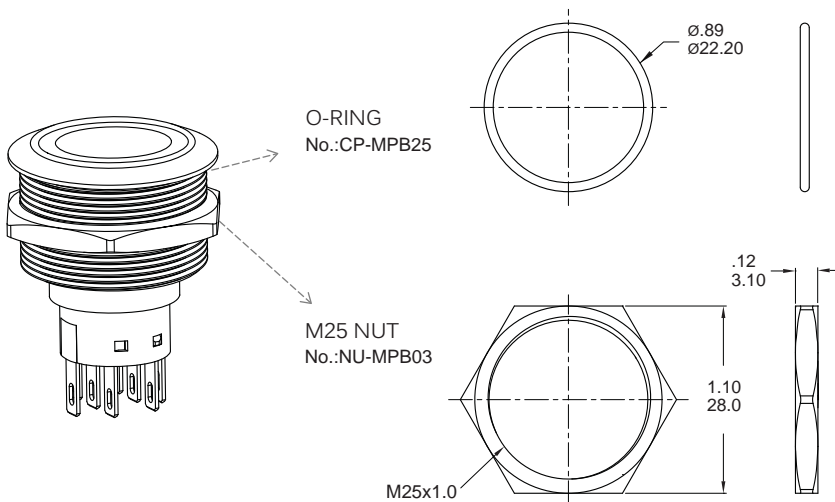

PANEL MOUNTING

Max. Panel thickness: 10.0mm [.39]

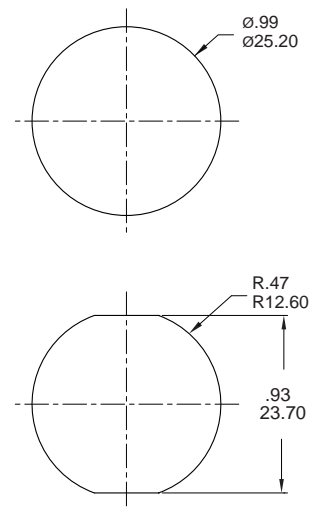

O-RING INSTALLATION

